

ROXIE - 1166NDW

ULTRA COMPACT - LED 300 W



- **Type:** Followspot
- **Source:** LED 300 W
- **Optics:** 10,5° to 22,5° zoom
- **Colour temperature:** Neutral Daylight White

Followspot

The little LED wonder with the power punch

Roxie is Robert Juliat's first LED followspot. The compact 300W spot is all about efficiency. It fits in the smallest of spaces and is the ideal energy-efficient solution for all those venues where running costs need to be significantly reduced. Roxie delivers an output comparable to most of the 575W discharge followspot available on the market. No heat, no lamp change, less maintenance. Smooth electronic dimming is available as standard, either locally via the rotary dimmer knob or remotely via DMX.

Features

- **Fully closing iris:** Removable for fast, easy replacement
- **Universal gobo holder:** A-size glass and metal gobo
- **Local control:** Light intensity adjustment through built-in potentiometer
- **Internal glass filter holder:** Long term use of durable coloured, dichroic or textured glass
- **Colour changer:** 6-way, 'push/pull' colour changer system for simultaneous use of multiple filters
- **DMX:** 8 or 16 bits dimming and strobe function
- **Parameters:** Adjustable curves and response thru 4-button display with automatic light switch-off
- **Easy focus reference:** Graduated scale on side of lantern; fast and easy refocusing

Optical

- **Very long-life lamp source:** 50 000 hours - Lumen maintenance greater than 70% after 50 000 hours
- **Variable zoom optics:** Sharp focus at every beam angle
- **Perfect dimming:** No clipping or cut-out below 20%; high quality smoothing
- **No colour shift:** Colour temperature remains the same when dimming

Construction

- **Made in France :** Fully manufactured on the premises retaining complete control over all aspects of quality
- **PSU:** Built-in electronic flicker-free power supply for easy, plug and play installation
- **Power connectors:** NeutriK® powerCON TRUE1 in and out connectors for daisy chaining
- **Silent-running cooling fans:** Ideal for TV studios and opera houses
- **Bodywork:** Strong sheet metal construction for durability
- **Moving parts:** Smooth at all times, even when hot
- **Captive knobs and handles:** Additional security when working at height or in transit
- **Easy access to all parts:** Easy cleaning, re-lamping and maintenance
- **Easy access to all parts:** Easy cleaning and maintenance

Picture:1166

DSEN251_1166NDW - 04/05/2016

Robert Juliat reserves the right to change or alter any of the items detailed on this page, to increase or improve manufacturing techniques without prior notice.

Robert Juliat S.A.S., 32 rue de Beaumont, 60530 Fresnoy-en-Thelle - France
Telephone : +33 (0)3 44 26 51 89 - fax : +33 (0)3 44 26 90 79 - info@robertjuliat.fr
www.robertjuliat.com



ROBERT JULIAT

Source

- **Lamp type:** LED
- **Power:** 258 W

| LED specifications | Power * | Lumen output* | Colour temperature* | Life* | CRI* (min) |
|-----------------------------|---------|---------------|---------------------|----------|------------|
| SUHD60 V2 NDW (RJ / Osram) | 258 W | 21 700 lm | 5000K | 46 000 h | 82 |

(*) manufacturers data

Optics

Characteristics

- **Type:** Zoom
- **Beam range:** 10,5° to 22,5°
- **Focal length:** 184 - 374 mm

Gel filter

- **Shape:** Circle
- **Standard size:** 165 mm (6.5 in)

Gobo

- **Size:** A
- **Material:** Metal
Glass

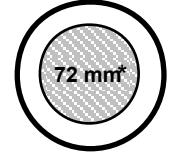

100 mm

*Maximum image size

Photometrics

with SUHD60 V2 NDW (RJ / Osram) source

• Optics @ 10.5°

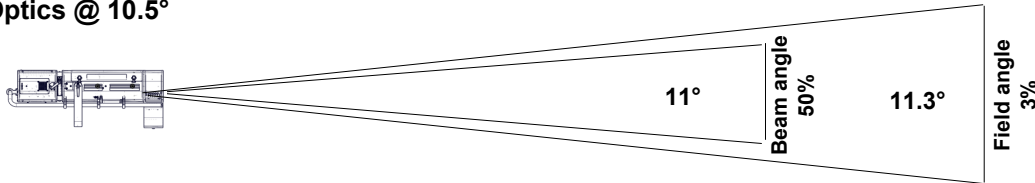

Beam intensity
252 000 cd

Field lumens
5 770 lm

Efficacy
19 lm/W

CCT
5 030 K

CRI
85

| | | | | | | |
|---------------------|------------|-----------|-----------|---------|---------|---------|
| Distance | 5 m | 10 m | 15 m | 20 m | 25 m | 30 m |
| Diameter | 1 m | 2 m | 3 m | 4 m | 4.9 m | 5.9 m |
| Illumination | 10 500 lux | 2 550 lux | 1 150 lux | 640 lux | 410 lux | 290 lux |
| Distance | 15 ft | 35 ft | 50 ft | 65 ft | 80 ft | 100 ft |
| Diameter | 3 ft | 6.9 ft | 9.9 ft | 12.9 ft | 15.8 ft | 19.8 ft |
| Illumination | 1 150 fc | 210 fc | 110 fc | 60 fc | 40 fc | 26 fc |

• Optics @ 22.5°

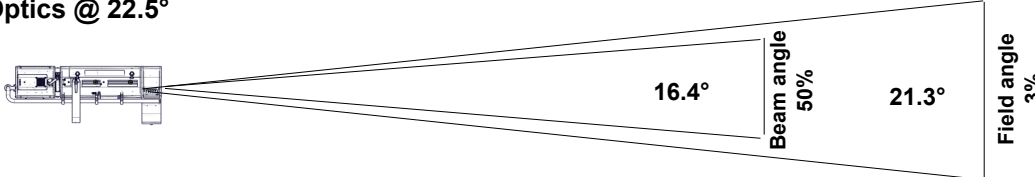

Beam intensity
104 200 cd

Field lumens
6 670 lm

Efficacy
22 lm/W

CCT
5 050 K

CRI
85

| | | | | | | |
|---------------------|-----------|-----------|---------|---------|---------|---------|
| Distance | 5 m | 10 m | 15 m | 20 m | 25 m | 30 m |
| Diameter | 1.9 m | 3.8 m | 5.6 m | 7.5 m | 9.4 m | 11.3 m |
| Illumination | 4 200 lux | 1 050 lux | 470 lux | 270 lux | 170 lux | 120 lux |
| Distance | 15 ft | 35 ft | 50 ft | 65 ft | 80 ft | 100 ft |
| Diameter | 5.6 ft | 13.2 ft | 18.8 ft | 24.4 ft | 30.1 ft | 37.6 ft |
| Illumination | 470 fc | 90 fc | 42 fc | 25 fc | 17 fc | 11 fc |

Remote control

- **Data protocol:** USITT DMX512-A
RDM

- **Data IN connector:** 5 pins XLR male
- **Data OUT connector:** 5 pins XLR female



• DMX chart:

Mode 1 (2 channels)

Dimmer
Dimmer master

Mode 2 (3 channels)

Dimmer
Dimmer fine
Dimmer master

Mode 3 (4 channels)

Dimmer
Dimmer fine
Strobe
Dimmer master

Dimensions and weight

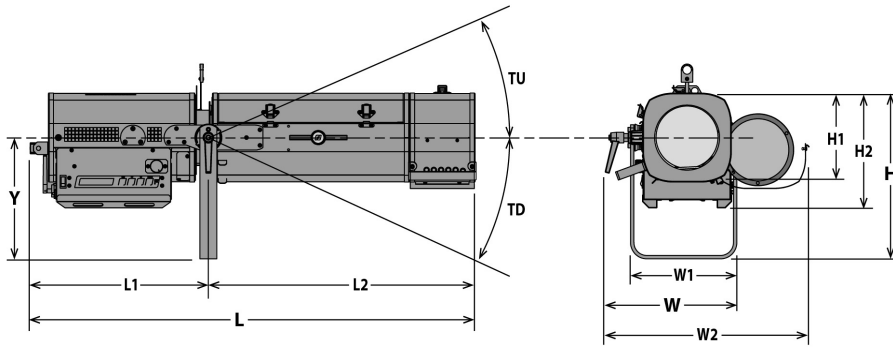

Weight: 20.5 kg (45.1 lbs)

| Height | Length | Width | Yoke | Tilt |
|----------------------|----------------------|----------------------|---------------------|---------|
| H= 387 mm (15.2 in) | L= 1045 mm (41.1 in) | W= 321 mm (12.6 in) | Y= 283 mm (11.1 in) | TU= 51° |
| H1= 208 mm (8.2 in) | L1= 418 mm (16.5 in) | W1= 249 mm (9.8 in) | | TD= 65° |
| H2= 268 mm (10.6 in) | L2= 627 mm (24.7 in) | W2= 490 mm (19.3 in) | | |

Shipping

- **Weight :**
- **Volume :**

Installation

- **Minimum distance to illuminated surface:** 0.6 m (1.8 ft)
- **Operating position:**

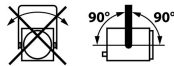

Warranty

- **Period: 2 years**
See General Sales Condition on website

Approvals



Construction

- **Housing:** Steel sheet - Aluminium
- **Colour:** Black
- **Cooling:** Low noise variable fan
- **Maximum ambient temperature (Ta):** 40°C (104°F)
- **Maximum case temperature (Tc) :** 70°C (158°F)
- **Total heat dissipation:** 1 126 BTU/h
- **Protection rating:** 20

Electrical compatibility

- 220/230 V - 50 Hz
- 220 V - 60 Hz
- 245 V - 50 Hz
- 100 V - 50 Hz
- 110/120 V - 60 Hz
- 100 V - 60 Hz
- 208 V - 60 Hz
- Selector: automatic detection

Power input



- **Type:** removeable power cord with Neutrik powerCON TRUE1 connector (included)
- **Cable:** H07RNF 3G1.5
- **Length:** 3 m (9,8 ft)
- **Power connector:** CEE 7/7 (2P+E NF/Schuko)

Power consumption

| Voltage | Frequency | Current | Power | Power factor |
|---------|-----------|---------|-------|--------------|
| 230 V | 50 Hz | 1.5 A | 330 W | 0,96 |
| 120 V | 60 Hz | 2.8 A | 330 W | 0,9 |
| 100 V | 60 Hz | 3.3 A | 330 W | 0,9 |



Power Supply Unit

- **PSU:** Internal - Electronic PSU - Flicker free with PFC
- **Control:** Local / DMX
- **Protection:** Mains: 4A 1P1D breaker - UL /
- **Power thru:** Neutrik powerCON TRUE1 - Maximum of 10 units (230 V) / 5 units (110 V)











Model

| | |
|----------------|--|
| 1166NDW | LED 300 W Followspot - 1166NDW Roxie - Neutral Daylight White - 10,5/22,5° |
|----------------|--|

Options

| | | |
|----------------|---|---|
| W-DMX/Z | W-DMX wireless DMX |  |
| FC1124 | Flight-case for Ultra Compact range + GT stand - Dim: 1210x600x560mm - Poids: 35 Kg |  |

Accessories

| | | |
|-------------------|--|---|
| IS750 | Full closing iris with holder - Weight: ,35 Kg 1 included |  |
| PF1114 | Ø165 mm metal filter holder 1 included |  |
| SGUX | Universal "A" size gobo-holder (metal, glass, frosted glass) 1 included |  |
| M165TP | 6 ways "push/pull" colour changer - Weight: 2,09 Kg 1 included |  |
| GT1000 | Tripod stand - SWL: 40 Kg - max. height: 1550 mm - Weight: 9,27 Kg |  |
| GT800 | Tripod stand - SWL: 40 Kg - max. height: 1550 mm - Weight: 7,98 Kg |  |
| T4000 | Followspot mount for Ø50mm pipe (suspension or overhead) - SWL= 100 Kg - Weight: 4,88 Kg |  |
| VD120 | 120x120mm frosted glass |  |
| Kit TELRAD | Telrad followspot sight with raiser and universal mounting kit - Weight: 1,23 Kg |  |
| FC1124/S | Flight-case for Ultra Compact range + GT stand - Weight: 35 Kg |  |
| W/GT800 | Set of 3 wheels for GT800/1000 stand - Weight: 2,33 Kg |  |